

VISPRING

Luxury Beds - London 1901

Assembly Instructions and Care Guide

Thank you for purchasing a Vispring bed.

Please read this Assembly Instruction and Care Guide carefully. With the correct assembly and care, you ensure that your bed will last as long as possible, giving you the finest sleep for years to come.

Scan below or visit www.vispring.com/assembly-care-guide for online Assembly Instruction and Care Guide.

English, Nederlands, Français, Deutsch, Italiano,
Русский, Español, 中文



ASSEMBLY INSTRUCTIONS

5
On Delivery

6
Leg Fixing

10
Divan Assembly

14
Headboard Assembly

CARE GUIDE

22
Product Guarantee

23
Register your Guarantee

23
Guarantee and Complaints Procedure

24
Caring for your Mattress

25
Caring for your Divan and Headboard

26
Turning your Mattress

28
Upholstery Settlement

29
Customer Service

30
Frequently Asked Questions

ASSEMBLY INSTRUCTIONS

Many of our retailers will deliver and set up your Vispring bed for you. If for some reason this has not been arranged, and you wish to set up the bed on your own, please follow these Assembly Instructions carefully.



Our divans are heavy. We advise using two people during assembly, and please handle with care.

ON DELIVERY

1. Remove your new mattress, divan and/or headboard from the packaging.
2. Locate the divan's castors/legs and headboard fixing packs and put them to one side before discarding the packaging.
3. Dispose of the packaging responsibly. Please recycle cardboard and polythene packaging. Dispose of all other packaging safely at a controlled waste unit.

(Your old mattress can, in most cases, be responsibly disposed of by your retailer upon the delivery of your new bed. If you do not have this option, please check with your local recycling centre and they can advise you on how to best dispose of your bed.)

- Due to the high volume of natural materials used in Vispring mattresses, the product is very heavy. We recommend at least two people lift the mattress.
- Our divans and headboards are made using solid wood and other natural materials; they are very heavy and require at least two people to set up.

NOTE: You may notice that on arrival, your mattress looks slightly smaller than your divan base. Occasionally, depending on shipping method and times, mattresses can contract a little during transit (up to 10cm/3.9"), but we assure you that your mattress will return to its normal size with use. Regular dressing and plumping of the mattress will speed up this process.



Beware of any protruding staples that may have detached from the leg/castor bag and, in the case of drawer divan when removing the drawers' transit straps.



To avoid the danger of suffocation please keep the polythene packaging away from babies and children

LEG FIXING

Most of our legs simply screw into the divan base. Legs L3 and L5 need to be screwed in using bolts. Bolts and washers will be supplied with legs when/as needed.

1. Lean the divan base(s) against the wall.
2. Attach castors/legs.
3. If you are using the metal linking bar and castors to link, please proceed to page 13.
4. Lower the divan base(s) back to the floor.

Please attach legs to the divan base before you continue to the next step of assembly. If you are using castors to link two divan bases together, please proceed to page 11.

ATTACHING L5 LEGS

NORTH/SOUTH LINKED DIVANS – ONE-PIECE MATTRESS

1. Position the divans adjacent to each other, lift the divans onto their head-ends to reveal the underside and support them against a wall.
2. Locate the two centre legs and their bolts and washers. Thread the bolts onto the washers and insert the bolts through the leg into the two identified captive nuts so that the leg is outermost and nearly flush with the edge of the divan.
3. Tighten the bolts with a screwdriver. The remaining corner legs should be bolted in the same way, using just one bolt and washer per leg. As the leg has the potential to rotate, it is fixed with two wood screws that should be screwed through the pre-drilled holes into the timber frame of the divan. Take care to ensure that these screws are inserted straight as the timber into which you are screwing is just 20mm thick.



Our divans are heavy. We advise using two people during assembly, and please handle with care.

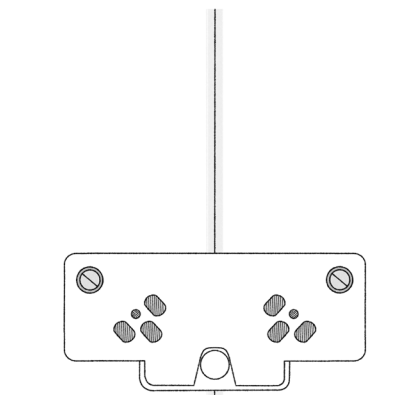

EAST/WEST SPLIT DIVANS

The process for this divan configuration is the same as above but the divan halves should be lifted onto their sides instead of the head-ends.

NORTH/SOUTH LINKED DIVANS – ZIPPED MATTRESSES AND SINGLE DIVANS

There are no centre legs in these configurations. Simply fit four corner legs to each divan as described above.

Please note this leg is not suitable for divans fitted with the hidden leg option.

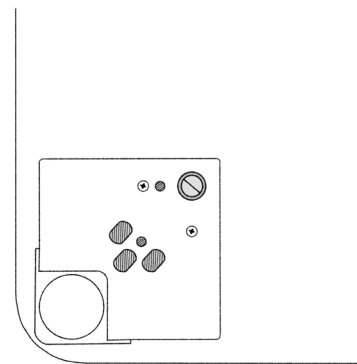

Our divans are heavy. We advise using two people during assembly, and please handle with care.

ATTACHING L3 LEGS

NORTH/SOUTH LINKED DIVANS – ONE-PIECE MATTRESS

1. Position the divans adjacent to each other, lift the divans onto their head-ends to reveal the underside and support them against a wall.
2. Locate the two centre legs and their bolts and washers. Thread two bolts onto the washers and insert the bolts through the leg into the two identified captive nuts so that the leg is outermost and nearly flush with the edge of the divan.
3. Tighten the bolts with a screwdriver. The remaining corner legs should be bolted in the same way, using just one bolt and washer per leg. As the leg has the potential to rotate, it is fixed with two wood screws that should be screwed through the pre-drilled holes into the timber frame of the divan. Take care to ensure that these screws are inserted straight as the timber into which you are screwing is just 20 mm thick.

EAST/WEST SPLIT DIVANS

The process for this divan configuration is the same as above but the divan should be lifted onto their sides instead of the head-ends.



Our divans are heavy. We advise using two people during assembly, and please handle with care.

NORTH/SOUTH LINKED DIVANS – ZIPPED MATTRESSES AND SINGLE DIVANS

There are no centre legs in these configurations. Simply fit four corner legs to each divan as described above.

Please note this leg is not suitable for divans fitted with the hidden leg option.

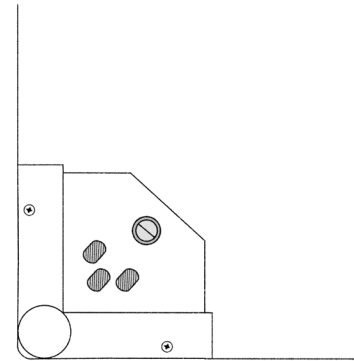

Our divans are heavy. We advise using two people during assembly, and please handle with care.

DIVAN ASSEMBLY

Our larger divans consist of two bases that are linked together. There are three ways to link divan bases, depending on the size or the leg used. Please follow the instruction applicable to your base. **TIP:** If you have a skirted divan, we suggest you keep the protective wrap on the skirt until you have linked your divan bases. This will prevent damage to the skirt during assembly.

JOINING TWO DIVAN BASES WITH A METAL LINKING BAR

1. Lean the divan bases against the wall, side-by-side.
 - For divans split North-South stand the bases on their head-end.
 - For divans split East-West stand the bases on their side.
2. Align the two divan bases so the hook and pin are levelled.

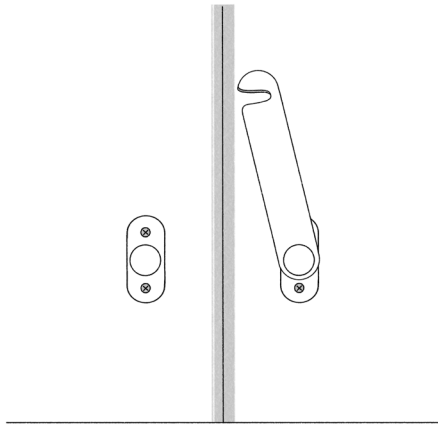

3. Push the metal bar down so it hooks over the pin on the opposite divan base.

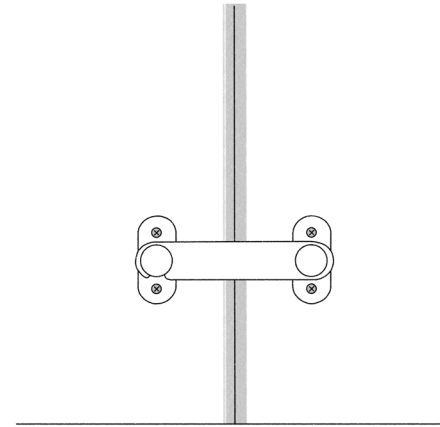

4. Lower the divan base(s) back onto the floor.



Our divans are heavy. We advise using two people during assembly, and please handle with care.



Our divans are heavy. We advise using two people during assembly, and please handle with care.

JOINING TWO DIVAN BASES WITH A METAL HINGE

1. Lean the divan bases against the wall, side-by-side on their head-end.
 - For divans split North-South stand the bases on their head-end.
 - For divans split East-West stand the bases on their side.
2. Align the hinges on each base and remove the pins.

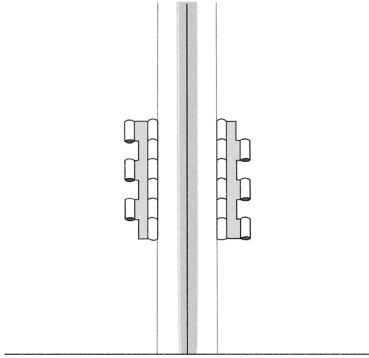

3. Mesh the two halves of the hinges to create a through which to pass the pin. Insert the pin.

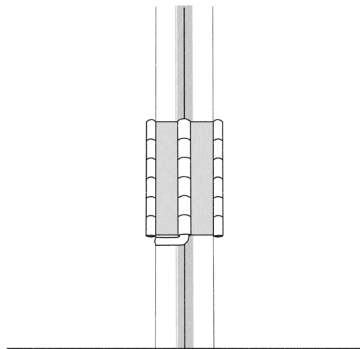

Lower the divan base(s) back onto the floor.

TIP: If you are struggling to fit the hook the hinges try to angle, or slightly crank the divan bases.



Our divans are heavy. We advise using two people during assembly, and please handle with care.

JOINING TWO DIVAN BASES WITH A METAL LINKING BAR USING CASTORS

1. Lean the divan bases against the wall, side-by-side on their head-end.
 - For divans split North-South stand the bases on their head-end.
 - For divans split East-West stand the bases on their side.
2. Place the metal linking bar on top of the two locating marks.
3. Place the metal washer on top of the metal plate.
4. Screw in the castor and secure tightly.
5. Repeat the process for the second centre castor.
6. Ensure all other castors have been screwed into the divan base.
7. Lower the divan base(s) back onto the floor.

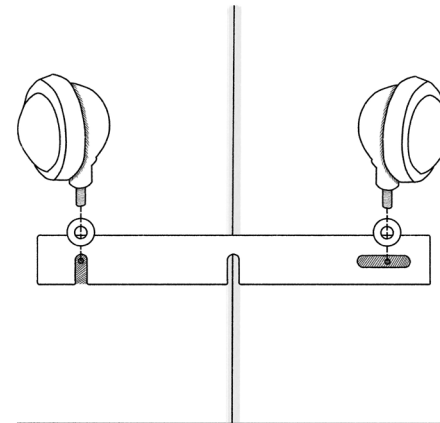

Our divans are heavy. We advise using two people during assembly, and please handle with care.

HEADBOARD ASSEMBLY

BOLT THROUGH HEADBOARD FIXING

When ordered together with a bolt through headboard, your divan base(s) will have pre-cut holes in the fabric where the headboard should be fitted. These holes will be identified with paper stickers to allow easy location.

FIXING PACK CONTENTS

2x locating pins

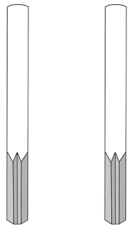

4x bolts

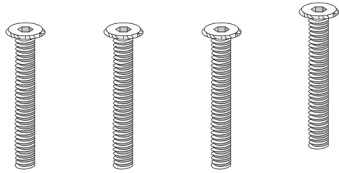

4x washers

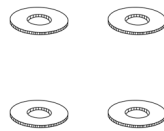

You will get one fixing pack for beds size up to and including 150 cm wide (5ft), and two fixing packs for beds larger than that.

1. Insert the locating pins into the top outside holes in the divan base.

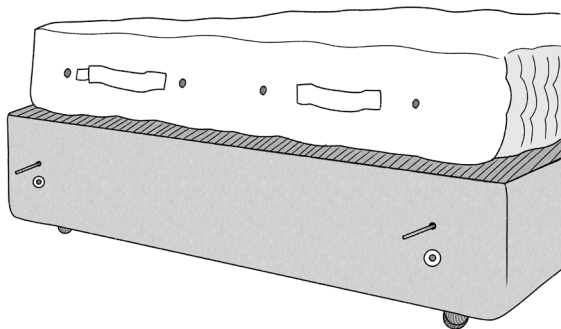

2. From the back of the headboard lift the lower fabric flap, which is held down by Velcro. This will expose the headboard mounting holes. For ease of installation, lightly tape the flap up with clear packing tape or another tape that will not leave glue marks or damage the fabric. Slide the headboard into place against the divan base using the alignment pins as guides.

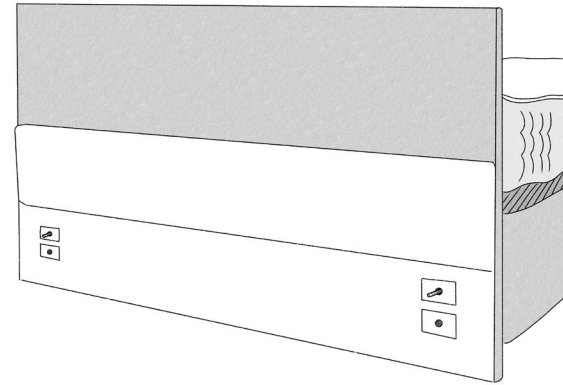

3. Install the mounting bolts into all the visible holes. Do not tighten completely at this point but leave them slightly loose in case minor adjustment of the headboard is required to fit all the bolts. Remove the alignment pins and put the remaining two bolts in their place.

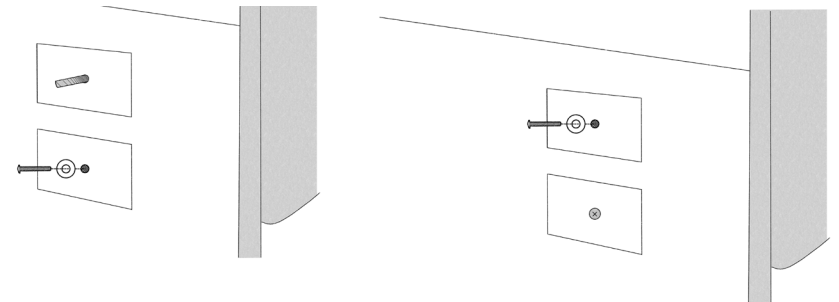

TIP: Sometimes, the pre-cut holes may need to be made very slightly bigger to allow for the thread of the bolt to be accessed. This can be achieved by using a sharp pair of scissors.

- Align the headboard so it is at the centre of the base, and so the height is correct. Now you can tighten all the bolts to ensure no further movement. Remove the tape holding up the fabric flap and lower the flap allowing the Velcro to re-attach.

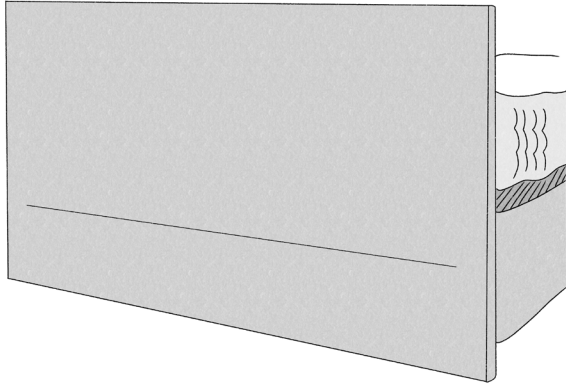

SLOTTED HEADBOARD FIXING (EURO-STYLE FITTING)

- Check the alignment of the divan brackets with the headboard brackets.

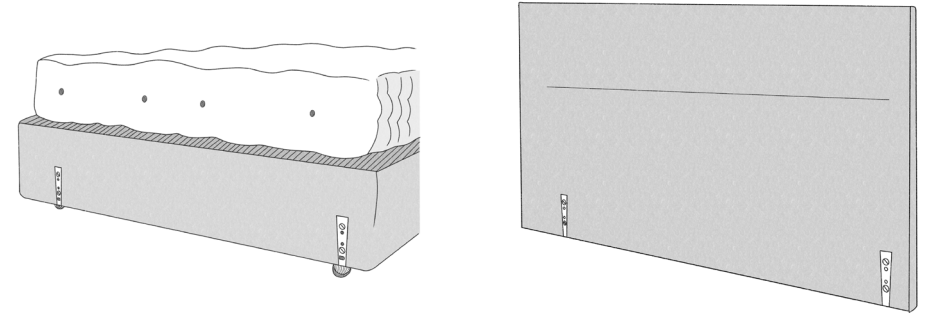

- Get assistance to lift the headboard to ensure the brackets can slide into the divan brackets. Gently push the headboard down, taking care not to use too much force.

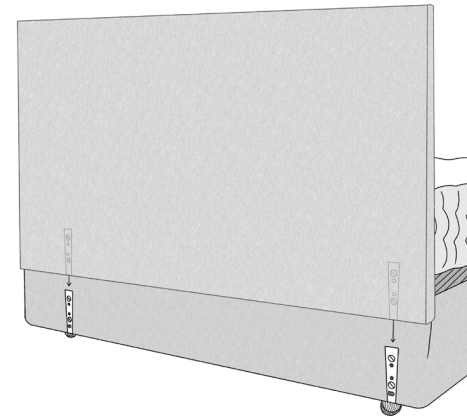

- Stand back and check that the headboard is level with the divan edge.

TIP: Gently loosen the bolts on the divan brackets to get easy alignment. Once fitted, remove the headboard and retighten the bolts ensuring the brackets do not move, now refit the headboard.



Our divans are heavy. We advise using two people during assembly, and please handle with care.

STRUTTED HEADBOARD FIXING (UK-STYLE FITTING)

UK struts are already attached to the headboard and swung behind the board when delivered. Bolts should be removed first. Struts positioned and then bolted.

1. Place the headboard front face down on a firm flat surface.
2. Remove all bolts from the rear of the headboard.
3. Attach all the struts to the headboard using the same bolts. Do this by passing the bolts through the holes in the struts into the pre-drilled holes in the rear of the headboard.
4. Tighten all the bolts on the headboard.
5. Untighten all the bolts in the head end of the divan sufficiently to allow the headboard struts to pass between the bolt head and divan.
6. Lower the slots in the headboard struts over the bolts and adjust the headboard to the correct height. Once happy with the position, tighten all bolts clamping the struts to the divan.

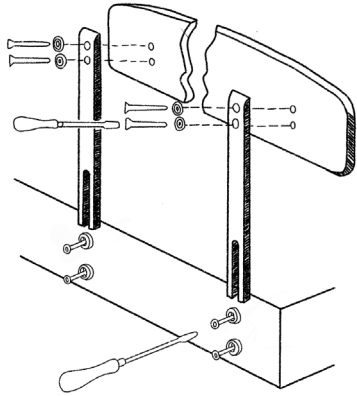

Our divans are heavy. We advise using two people during assembly, and please handle with care.

DRAWER DIVAN

When you receive your drawer divan, the drawers are secured using transit straps. Please remove the straps to access the drawers.

Beware of any protruding staples that may have detached when removing the transit straps and use a pair of pliers to remove and dispose of carefully

If you need to remove the drawers from the base, place your hands underneath each side of the drawer and push the grips outward.

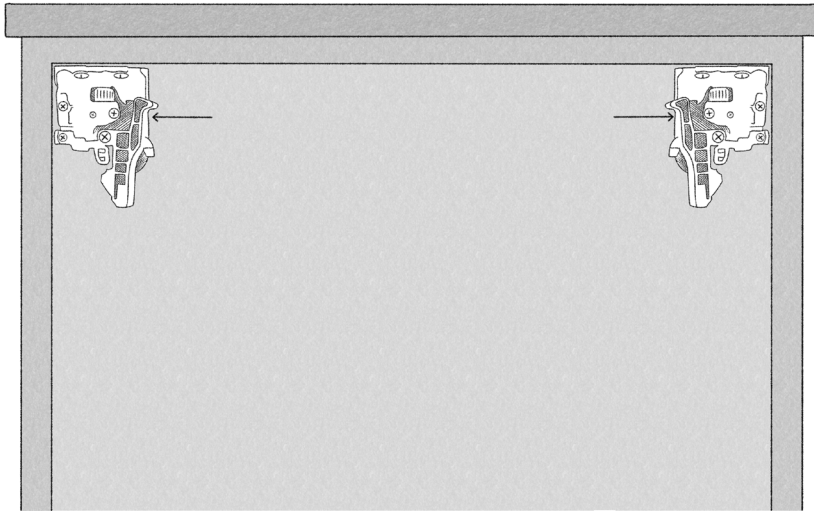

To refit the drawer, fully extend the drawer runners. Lay the drawer on the runners. Gently push the drawer closed while slightly lifting the drawer front (lift approx. 1cm). As the drawer fully closes you should hear a slight click as the mechanism fully engages. Test by opening the drawer and pushing closed with sufficient force to activate the soft close mechanism. If the soft close does not work, remove the drawer and repeat the process.

MATTRESS PAD PLACEMENT

When used on a slatted base, the mattress pad will prolong the mattress's life by:

- Protecting the mattress underside from ticking surface damage caused by the slats when turning the mattress.
- Cushioning from indentations caused by the slats that may result in visible lines on the mattress surface.
- Ensuring colour does not transfer from the slats.
- Protecting against moisture from the slats.

Attaching the mattress pad to the slatted base is easy. Using the supplied laces and the eyelets, tie the pad to the slats of the bed frame. Without securing the pad, the mattress and pad may slide on the slats. The placement of the mattress pad is essential as if the mattress ticking is damaged or ripped due to the slats, the guarantee will be invalid.

CARE GUIDE

PRODUCT GUARANTEE

The quality of the materials and craftsmanship that goes into every Vispring luxury mattress and bed ensures their owners, with correct care, can enjoy many years of the finest sleep. How long you can, or want to, keep your mattress is usually down to personal preference and how well you have cared for your mattress. Most of our customers enjoy decades with their Vispring mattresses. However, it is important not to confuse how long you can enjoy your Vispring mattress with our guarantee. The guarantee is designed to protect you in the unlikely event of damage that is due to faulty workmanship or components.

The length of the guarantee varies depending on the product you have purchased:

Product	Guarantee Length
Mattress and Divan Sets	30 Years
Mattresses only	30 Years
Ottoman Divans	5 Years 1 Year for gas struts
Headboards	2 Years
Mattress Toppers	5 Years
Pillows and Duvets	2 Years
Mattress Protectors and Pads	12 months

REGISTER YOUR GUARANTEE

To advise us of your new mattress and/or divan purchase do not forget to register your guarantee. The best way to register your guarantee is on our website: <https://www.vispring.com/register-your-guarantee/>.

If you are unable to register your guarantee online, please speak to our Customer Services team. Contact details on page 31.

GUARANTEE AND COMPLAINTS PROCEDURE

If, during the guarantee period, your product requires attention please contact the store where you made your purchase. This is because the purchase contract lies between yourself and your retailer. Our retailers are highly trained and will be able to provide you with advice on how to proceed. If needed, they will contact Vispring on your behalf.

Depending on what product the claim refers to, Vispring may arrange for an independent inspector to visit your home. If the outcome of the inspector's report shows that the Guarantee-claim is valid, Vispring will either repair or replace the product.

The guarantee does not cover faults occurring due to unreasonable or improper use. Examples where the guarantee may become invalid:

- If the mattress is soiled and unsanitary
- If the mattress has been rolled or folded
- If the mattress has been placed on an unsuitable base
- Excessive wear and tear or other misuses of the product
- If the mattress is stained because a mattress protector has not been used

For full details on the guarantee, please see Terms & Conditions on <https://www.vispring.com/terms-and-conditions>

CARING FOR YOUR MATTRESS

- As your new mattress contains a range of natural materials, sometimes an 'organic' odour can be detected when the product is new. If this happens, please open the windows in your room, allowing the mattress to air out and the odour to disperse.
- Allow your mattress to breathe and never place any plastic between the mattress and the divan or frame top surface. This would encourage condensation and could damage your mattress.
- We advise you to pull back your bed linen every day to allow your mattress to air, letting the natural fibres breathe and moisture evaporate after a good night's sleep.
- Having invested in a luxury mattress, we strongly recommend that you cover the mattress with a good quality washable mattress protector.
- Dust and fluff can be removed from your mattress using a soft brush. Vacuum cleaners must not be used as they can dislodge fillings.
- Stains and spillages should be soaked up with a dry absorbent cloth. Do not 'wet clean' as this could damage the upholstery.
- Do not worry if the tufts on your mattress ever snap – they are designed to keep all the luxurious fillings in place and will break if put under a lot of pressure. The good news is that they are easy to replace and are covered by Vispring's 30-year guarantee.
- Try to avoid sitting on the edge of your bed for long periods of time as it puts pressure on the edge springs and could break the border stitching.
- As tempting as it is, do not let children bounce up and down on the bed as it will damage the springs.
- Do not bend or roll your mattress, as it can damage the springs (and invalidate your 30-year guarantee). If you need to move your mattress, e.g., when moving house, please ensure your mattress is well wrapped and laid flat or stored horizontally.
- We recommend turning your mattress twice a week for the first three months and with the seasons after that. This is to firstly encourage natural and even settlement of the mattress fillings and subsequently to extend its life. Further details are on pages 26-29.

CARING FOR YOUR DIVAN AND HEADBOARD

- If spillage occurs blot dry using a colourfast cloth or plain kitchen roll to ensure no colour transfer. Do not use excessive pressure as this may cause damage.
- Dust and fluff can be removed from your divan and headboard using a soft brush.
- Minor marks and stains may be removed with a damp cloth and soapy water, depending on the fabric. To ensure no watermarks, please test on a small inconspicuous area first. If it leaves a watermark, please refer to a professional upholstery cleaner.
- Major cleaning of the divan and/or headboard fabric should only be conducted by a professional upholstery cleaner.
- Vispring does not accept liability for Third-party fabric protection treatments.
- To reduce colour fading please keep your bed out of direct sunlight.
- Some fabrics may be subject to pilling. This is not a fault and can be reduced by brushing lightly with a soft brush in the direction of the pile.
- Regularly check all screws and securing plates are kept tightly fastened to prevent weakening of the legs and castors.
- If you have purchased a divan with drawers, please ensure that you do not overload them with heavy items. The drawers are designed for lightweight items such as bed linen or clothing.

For details on our Ottoman Divan, please refer to the specific leaflet enclosed with the Ottoman.

CARING FOR YOUR TOPPER

- If spillage occurs blot dry using a colourfast cloth or plain kitchen roll to ensure no colour transfer. Do not use excessive pressure as this may cause damage.
- Dust and fluff can be removed from your topper using a soft brush.

USING A VISPRING MATTRESS ON A BEDSTEAD

- If you are using your mattress on a bedstead, please ensure that the gaps between the slats of the base are no more than 7.5cm (3") apart. This ensures that the springs in the mattress are properly supported.
- We recommend the use of a Vispring mattress pad, this will serve as a protective layer between your mattress and the base of your bedstead. The mattress pad will prolong the life of your mattress when it is used on a slatted base, as it will prevent indentions and protect against moisture from wooden slats. For more information please see page 21.
- A mattress pad is required to comply with the 30-year guarantee on any Vispring mattress that has been placed on a slatted base.

TURNING YOUR MATTRESS

All Vispring mattresses are filled with the finest natural materials; because of this, the fillings will bed down more at the body's heaviest contact points. Turning your mattress will allow the fillings to redistribute throughout, helping its recovery and longevity.

We advise you to turn your mattress twice a month for the first three months and once each season after that.

We recommend at least two people to turn your mattress as they can be very heavy, depending on size.

1. Slide the mattress down towards the foot end of the divan for about $\frac{3}{4}$ of its length.

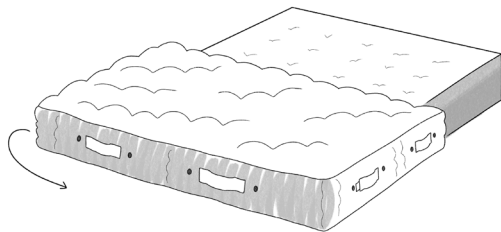

2. Rotate the mattress in either direction through 90°.

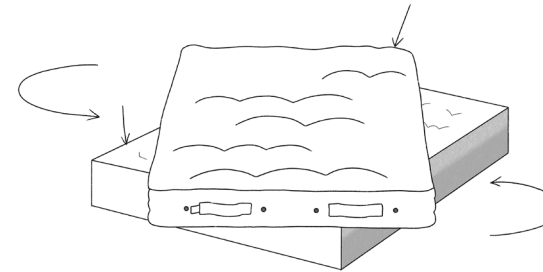

3. Lift the mattress onto its border on top of the divan. Gently allow the mattress to fall back onto the divan towards the head end.

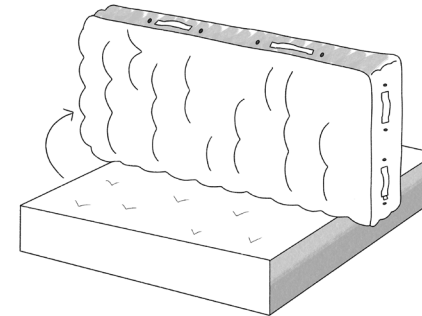

3. Rotate the mattress through 90° in either direction depending on whether you need to change the sides (not applicable for combination mattresses).

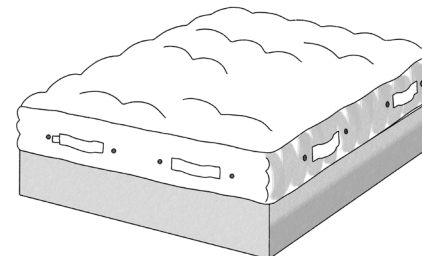

Product	Turning Method
Single Tension Mattresses	Alternating the turning method is required. First time: Turn the mattress right over from head to foot. Second time: Rotate the mattress through 180°. Third time: Turn the mattress right over from head to foot. Fourth time: Rotate the mattress through 180°.
Combination/Dual Tension Mattresses	If you wish to retain your normal sleeping side of the bed, the mattress can only be turned head to foot and then foot to head next time you turn.
Single Tension Zipped Mattresses	Zips should be unfastened before turning/rotating. Turn both mattresses over side to side and rezip. The next time rotate through 180°. Alternate this method each time you turn your mattress.

UPHOLSTERY SETTLEMENT

Vispring mattresses have extremely generous upholstery designed to complement the springs and follow the body contours. Natural upholstery takes longer to settle than man-made materials. It is impossible to stipulate the exact settlement period, as the time will vary depending on the filling types and quantities. It may also depend on the weight and sleeping pattern of the individual(s) using the mattress.

Normally the upholstery in the centre of the mattress, where most of the body's weight is concentrated, will 'bed down' quicker. Should you find at the early stages of the mattress's life that settlement is uneven and visually undesirable, we suggest that you turn your mattress in accordance with our guidelines, see p.26. This will balance out the pressure, allowing the fillings to settle more evenly while you sleep on the opposite side of the mattress.

CUSTOMER SERVICE

Our Customer Service team is happy to answer any questions you might have regarding your new Vispring bed. Please note that any guarantee queries should go to your retailer in the first instance.

United Kingdom

Email: info@vispring.com

Phone: +44 (0)1752 366311

Europe, Middle East and Africa

Email: infoeurope@vispring.com

Phone: +32 2 403 3676

Americas

Email: cs@vispring.com

Phone: +1 888 298 5795

Asia

Email: csasia@vispring.com

Phone: +44 (0)1752 366311

Rest of the World

Email: info@vispring.com

Phone: +44 (0)1752 366311

FREQUENTLY ASKED QUESTIONS

Q HOW LONG DOES IT TAKE TO GET USED TO A NEW MATTRESS?

- A Your Vispring mattress can feel slightly firmer than the retailer display model, which has been tried by other customers, so the 'bedding down' process has already begun. We recommend using the mattress for a minimum of 4-6 weeks to allow the fillings in your mattress to settle, in some cases it takes a little longer, however you will start to notice given this time, that the fillings will start to soften.

Q MY NEW MATTRESS LOOKS SHORT ON MY BED BASE. HOW LONG DOES IT TAKE A POCKET SPRUNG MATTRESS TO EXPAND?

- A As our collections consist of only pocket sprung mattresses, you may notice that on arrival your mattress looks slightly smaller than your divan base. Occasionally, depending on shipping method and times, mattresses can contract a little during transit (up to 10cm), but we assure you that your mattress will return to its normal size with use. Regular dressing and plumping of the mattress will speed up this process.

Q WHY DOES MY NEW VISPRING MATTRESS SMELL?

- A As your luxury Vispring mattress contains a range of natural materials, sometimes an 'organic' odour can be detected when the product is new. If this happens, please open the windows in your room, allowing the mattress to air out and the odour to disperse. Pull back your bed linen daily to allow your mattress to air, letting the natural fibres breathe and help any moisture to evaporate after a good night's sleep.

Q HOW OFTEN SHOULD YOU TURN A POCKET SPRUNG MATTRESS?

- A All Vispring mattresses are filled with the finest natural materials; because of this, the fillings will bed down more at the body's heaviest contact points. Turning your mattress will allow the fillings to redistribute throughout, helping its recovery and longevity. We advise you to turn your mattress twice a month for the first three months and once each season after that.

Q ARE MATTRESS BODY IMPRESSIONS NORMAL ON A POCKET SPRUNG MATTRESS?

- A Yes, it is normal for your mattress to form around your body contours. Both natural settlement and frequent turning will reduce compression marks over time.

Q HOW LONG DOES A VISPRING MATTRESS LAST?

- A The quality of the materials and craftsmanship that goes into every Vispring luxury mattress and bed ensures their owners, with correct care, can enjoy many years of the finest sleep. How long you can, or want to, keep your mattress is usually down to personal preference and how well you have cared for your mattress. Most of our customers enjoy decades with their Vispring mattresses.
However, it is important not to confuse how long you can enjoy your Vispring mattress with our guarantee. The guarantee is designed to protect you in the unlikely event of damage that is due to faulty workmanship or components.

Please see Vispring 30-year guarantee Terms and Conditions here: <https://www.vispring.com/terms-and-conditions/>

Q HOW DO I FIND OUT IF MY MATTRESS IS COVERED BY THE VISPRING 30-YEAR GUARANTEE?

- A Your product is guaranteed against structural failure and faulty workmanship. If during the guarantee period, your mattress requires attention, in the first instance, please contact the store where you made your purchase and provide details about your concern.

You can find all our retailers on our website: <https://www.vispring.com/find-a-store>

Scan below or visit www.vispring.com/assembly-care-guide for online Assembly Instruction and Care Guide.

English, Nederlands, Français, Deutsch, Italiano, Русский, Español, 中文



VISPRING

Luxury Beds - London 1901