

Model #

2098DUETa

Addison

72"H Bookcase

with Doors

DUET finish

Assembly Instructions

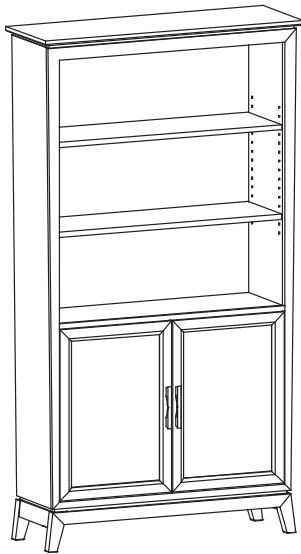

Thank you for allowing us to help you furnish your home. We are certain you will be delighted with your new furniture for many years to come.

IMPORTANT NOTES:

- For maximum stability, attach unit to the wall using the enclosed Tipping restraint.
- Wood can be susceptible to changing color over time when exposed to strong sunlight. Use window shades, drapes or blinds to protect your furniture. To help the surface age evenly and avoid dark and light spots, periodically move items to expose the entire surface to an even amount of light so it may develop a uniform patina.
- For normal household use only. *Not* recommended for commercial use.
- Do not climb, sit or stand on this piece of furniture.
- Do not overload the shelves on this unit.
- Unload items before you move this unit.
- This assembly requires two people.

⚠ WARNING

Children have died from furniture tipover. To reduce the risk of furniture tipover:

- ALWAYS install tipover restraint provided.
- NEVER put a TV on this product.
- NEVER allow children to stand, climb or hang on drawers, doors or shelves.
- Place heaviest items on the lowest shelves.

Use of tipover restraints may only reduce, but not eliminate, the risk of tipover.

Attention: Attached to the bottom of or included with this unit is a tipping restraint kit. When you receive your furniture, be sure to find and install the tipping restraint as instructed in the kit. If you cannot locate the restraint, please contact us immediately for replacement.

Drilling, sawing, sanding or machining wood products can expose you to wood dust, a substance known to the state of California to cause cancer. Avoid inhaling wood dust or use a dust mask or other safeguards for personal protection.

For more information go to: www.p65warnings.ca.gov/wood

This product can expose you to chemicals, including formaldehyde, which are known to the State of California to cause cancer.

For more information go to: www.p65warnings.ca.gov/furniture

DESIGN SUBJECT TO CHANGE WITHOUT NOTICE.

CUSTOMER SERVICE

If you ever have questions about your furniture, please do not hesitate to contact us. In the unlikely event you need a replacement part; we can make those parts available through an authorized Whittier Wood Furniture dealer. If you cannot order replacement parts through your dealer, please contact our customer service department.

Hours: Our friendly customer service staff can be reached:

Monday-Friday 8:00 a.m. to 5:00 p.m. (Pacific Time).

You may leave a message 24 hours a day, seven days a week.

Customer Service: 800-653-3336 • Outside the U.S.: 541-687-0213

Fax: 541-687-2060 • Email: info@whittierwood.com

**Whittier
Wood**
FURNITURE

P.O. Box 2827
Eugene, OR 97402 USA

Production Code:











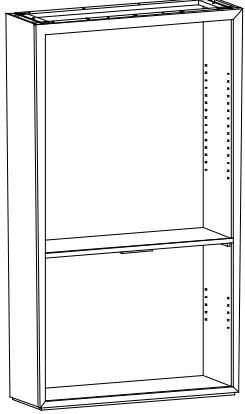

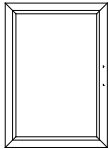
VN

05/21

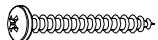
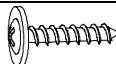
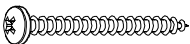
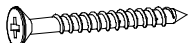

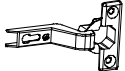



2098DUETa Addison 72"H Bookcase with Doors

Parts List

Please identify the parts and check that quantities received match those on this list.
If you need to replace a part, refer to the following letter and part name.

Part	Description		Quantity
A	Top Assembly		1
B	Case		1
C	Adjustable Shelf (attached)		3
D	Door (attached)		2
E	Base (attached)		1
F	#6 x 1/2" Undercut Screw (inserted)		12
G	#6 x 3/4" P.O Screw (inserted)		16
H	#6 x 3/4" Brass Flat Head Screw (inserted)		20
I	#8 x 1-1/4" Pan Head Screw (inserted)		41
J	#8 x 7/8" Black Lo-Profile Screw (inserted)		14
K	#8 x 1-3/4" Pan Head Screw (inserted)		12
L	#8 x 1-5/8" Black Screw (inserted)		8
M	#8 x 1-1/4" Machine Screw Tuscan (installed)		4
N	Hinge (attached)		4
O	Hinge Plate (attached)		4
P	1/4" x 20mm Insert Nut (inserted)		4
Q	5/32" x 10mm Insert Nut (inserted)		4
R	Black Walnut Pull (attached)		2

2098DUETa Addison 72"H Bookcase with Doors
Parts List

Part	Description		Quantity
S	Hex Bumper (attached)		4
T	Front 4-Hole Bracket (attached)		2
U	Back 6-Hole Bracket (attached)		2
W	Shelf Bracket (installed)		12
X	Slotted Leveler (installed)		4
Y	Leveler Adjustment Key (attached to Owners Manual)		1
TB	Bookcase Tipping Restraint (attached)		1 set

2098DUETa Addison 72"H Bookcase with Doors

Assembly Instructions

Tools Required: Phillips Screwdriver, Rubber Mallet or Padded Hammer.

Tool Provided: Leveler Adjustment Key in the Zip bag taped to the Owner's Manual and Safety Guide.

1. To move the Adjustable Shelves (C), remove the #6 x 1/2" Undercut Screws (F) and the Shelves (C). Reposition the Shelf Brackets (W) to the desired positions, replace the shelves and insert the screws. See Figures 1 and 1a.

Doors removed for illustration purposes.

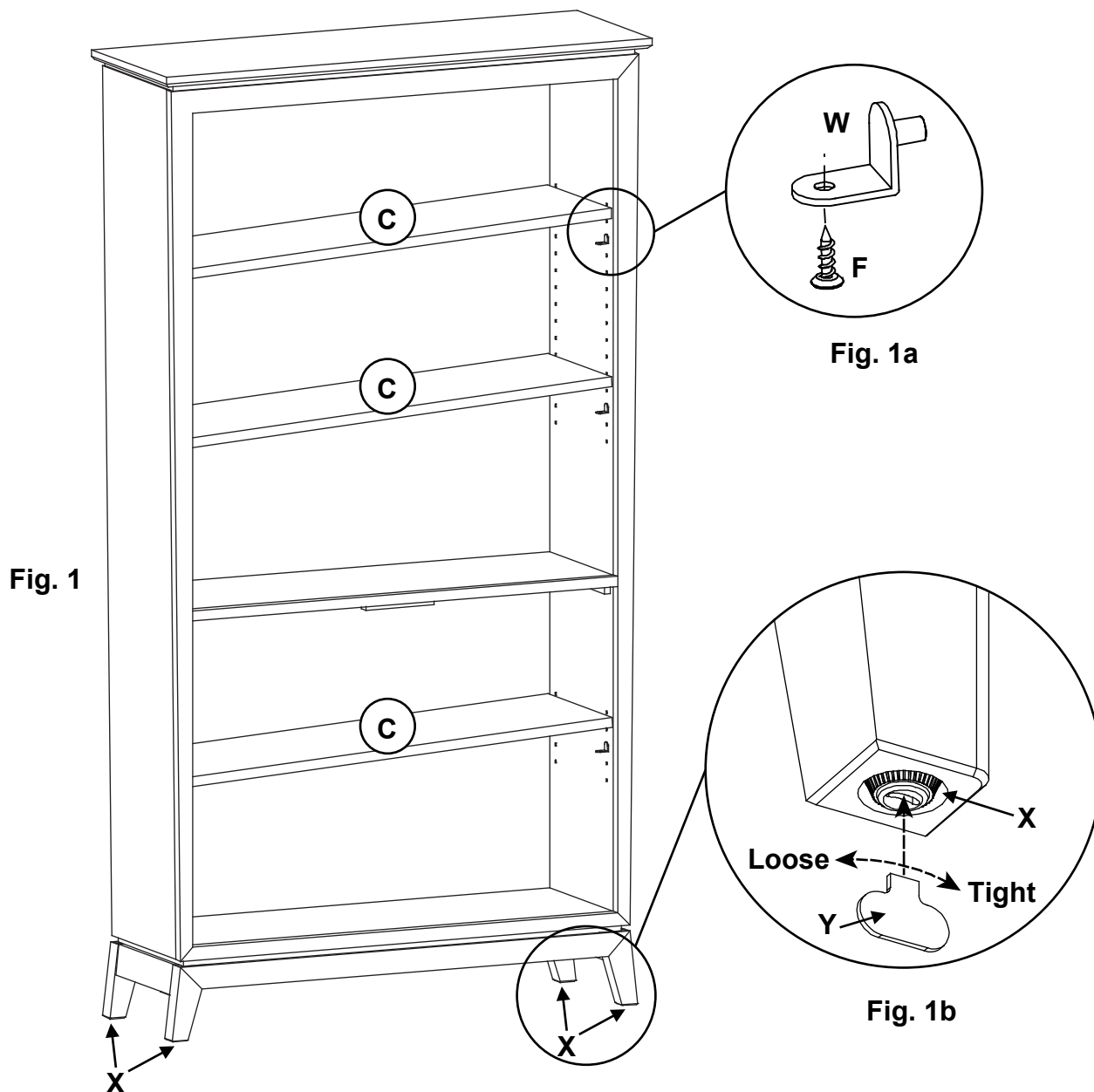

2. Place the bookcase at its final destination. Use the Leveler Adjustment Key (Y), found in the Zip bag taped to the Owner's Manual and Safety Guide to rotate the Slotted Levelers (X) on the bottoms of the legs until the unit is level. See Figures 1 and 1b.

2098DUETa Addison 72"H Bookcase with Doors

Assembly Instructions

3. The door may need to be adjusted so that all the spaces between the doors and unit sides are equal. To make those adjustments, follow the instructions in Figure 3.

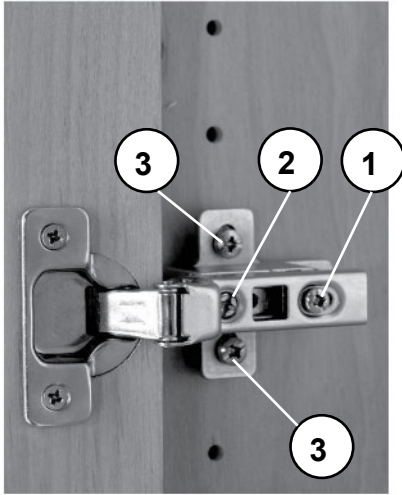

Fig. 3

Side adjustment

To move the door towards the side panel, rotate screw '2' counter-clockwise. To move it away, rotate screw '2' clockwise.

Depth Adjustment

Loosen screw '1' and adjust door. Re-tighten screw.

Height Adjustment

Loosen screws '3' and adjust door. Re-tighten screw.





If there is a problem with a Hinge (N), do not attempt to remove it. Contact Customer Service first.

Continued on Page 6

Bookcase Tipping Restraint Instructions

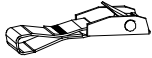
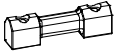
! Safety First! Anchor It! !

Before you begin this assembly, identify each part and make sure the quantities received match what is on this list. If you need to replace a part, contact Whittier Wood Furniture customer service and refer to the following list for its name and letter code.

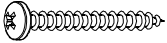
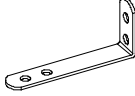
Part	Description	Quantity
A	Cam Buckle and Short Strap (installed) 	1
B	Plastic Bracket (installed) 	1
C	1" x 1000mm Long Strap (installed) 	1
D	#8 x 3" Pan Head Screw 	2
F	Washer (installed) 	1
G	#8 x 5/8" Pan Head Screw 	2 (1 inserted)
H	#8 x 1-1/4" Pan Head Screw 	1
I	"L" Angle Bracket 	1

If you have a stone or tile floor or do not wish to drive screws into the corner of the baseboard and floor see the instruction included inside the tipping restraint kit for an alternate installation.

Continued on Page 7

2098DUETa Addison 72"H Bookcase with Doors

Assembly Instructions

4. Decide where you want to place the piece of furniture in your room. Mark the baseboard with a pencil mark directly behind the location where the tipping restraint is attached to your item. Move the item away from the wall far enough to allow you to access the spot where the baseboard meets the floor. Position the straps and Plastic Bracket (B) as shown in Figures 4 and 4a with the angled corners of the Plastic Bracket (B) firmly placed against the seam of the baseboard and floor. Attach by driving #8 x 3" Pan Head Screws (D) through the holes in the Plastic Bracket (B) into the seam below the baseboard where it meets the floor. See Figures 4 and 4a.

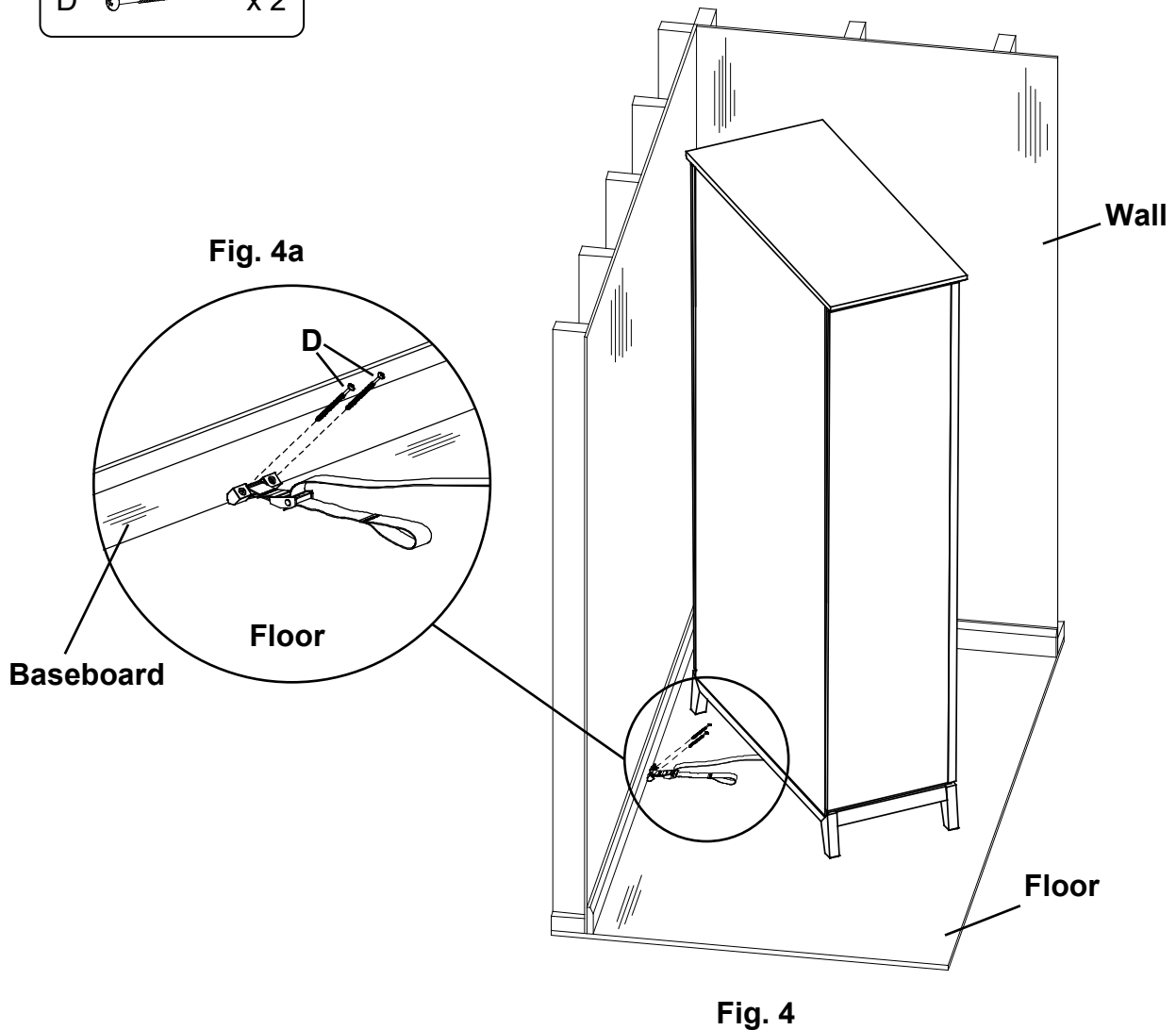

2098DUETa Addison 72"H Bookcase with Doors

Assembly Instructions

5. Move the item back into position against the wall and reach underneath the piece of furniture to grasp the loop in the free end of the strap. Pull the free end of the strap until portion between the Cam Buckle (A) and the back apron of the item is tight. See Figures 5 and 5a. If you need to move the piece of furniture reach beneath and locate the buckle which connects the two sections of the strap and depress the release lever, then pull on the section of strap that is between the buckle and the back apron of the furniture until there is enough slack to allow you to pull the item away from the wall.

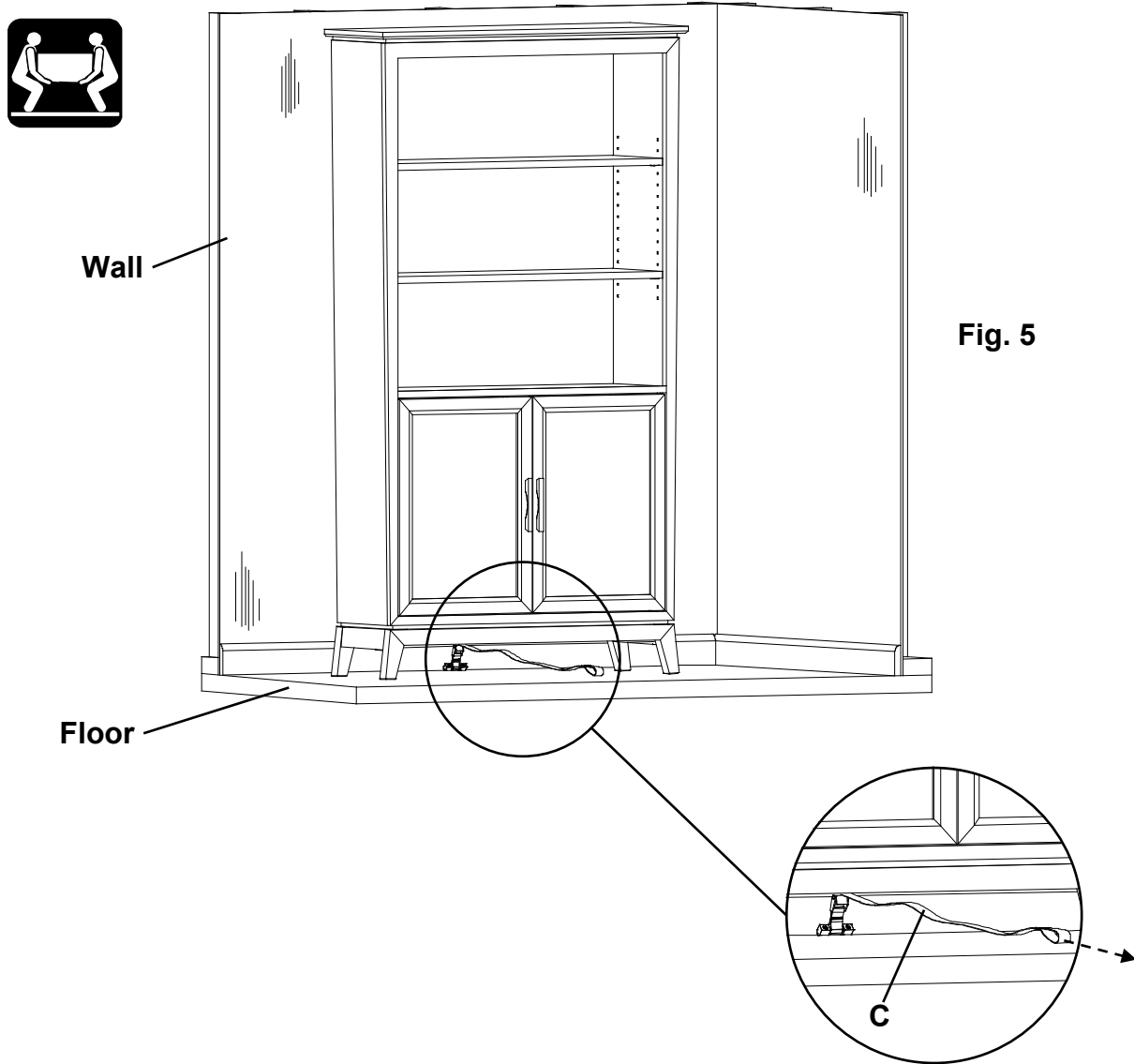

Fig. 5a