

Addison Sound Bar Media Consoles

DUET finish

Assembly Instructions

Model #

2093DUETb

Addison 54"W
Sound Bar Media
Console

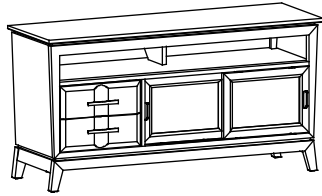

2094DUETb

Addison 64"W
Sound Bar Media
Console

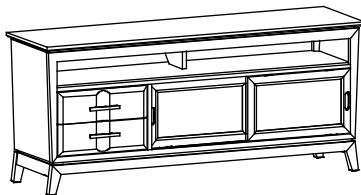

Thank you for allowing us to help you furnish your home. We are certain you will be delighted with your new furniture for many years to come.

IMPORTANT NOTES:

- Wood can be susceptible to changing color over time when exposed to strong sunlight. Use window shades, drapes or blinds to protect your furniture. To help the surface age evenly and avoid dark and light spots, periodically move items to expose the entire surface to an even amount of light so it may develop a uniform patina.
- For normal household use only. *Not* recommended for commercial use.
- Do not climb, sit or stand on this piece of furniture.
- Do not overload the drawers or shelves.
- Unload items before you move this unit.
- Before you begin your project, completely read the Assembly Instructions.
- This assembly requires two people.

WARNING

Children have died from furniture tipover. To reduce the risk of furniture tipover:

- ALWAYS install tipover restraint provided.
- NEVER allow children to stand, climb or hang on drawers, doors or shelves.
- NEVER open more than one drawer at a time.
- Place heaviest items in the lowest drawers.
- Refer to TV manufacturers User Guide for additional instructions to secure television.

Use of tipover restraints may only reduce, but not eliminate, the risk of tipover.

Attention: Attached to the bottom of or included with this unit is a tipping restraint kit. When you receive your furniture, be sure to find and install the tipping restraint as instructed in the kit. If you cannot locate the restraint, please contact us immediately for replacement.

Drilling, sawing, sanding or machining wood products can expose you to wood dust, a substance known to the state of California to cause cancer. Avoid inhaling wood dust or use a dust mask or other safeguards for personal protection.

For more information go to: www.p65warnings.ca.gov/wood

This product can expose you to chemicals, including formaldehyde, which are known to the State of California to cause cancer. For more information go to: www.p65warnings.ca.gov/furniture

DESIGN SUBJECT TO CHANGE WITHOUT NOTICE.

CUSTOMER SERVICE

If you ever have questions about your furniture, please do not hesitate to contact us. In the unlikely event you need a replacement part; we can make those parts available through an authorized Whittier Wood Furniture dealer. If you cannot order replacement parts through your dealer, please contact our customer service department.

Hours: Our friendly customer service staff can be reached:

Monday-Friday 8:00 a.m. to 5:00 p.m. (Pacific Time).

You may leave a message 24 hours a day, seven days a week.

Customer Service: 800-653-3336 • Outside the U.S.: 541-687-0213

Fax: 541-687-2060 • Email: info@whittierwood.com

**Whittier
Wood**
FURNITURE

P.O. Box 2827
Eugene, OR 97402 USA

Production Code:











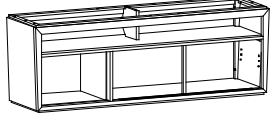

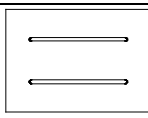
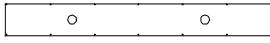
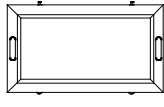
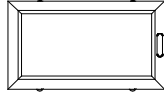
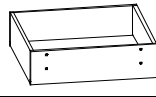
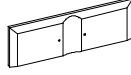
VN

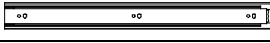
05/20

2093DUETb Addison 54"W Sound Bar Media Console
2094DUETb Addison 64"W Sound Bar Media Console





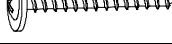
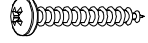
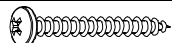
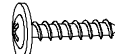
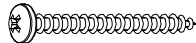





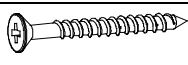

Parts List

Please identify the parts and check that quantities received match those on this list.
 If you need to replace a part, refer to the following letter and part name.

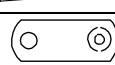
Part	Description	Quantity	
		2093DUETb	2094DUETb
A	Top Assembly (attached) 	1	1
Ba	Case 	1	1
C	Adjustable Shelf (installed) 	1	1
D	Removable Back (installed) 	2	2
E	Fitted Back (attached) 	1	1
F	Inside Door (installed) 	1	1
G	Outside Door (installed) 	1	1
H	Drawer Box (inserted) 	2	2
I	Drawer Face (installed) 	2	2
J	Base (attached) 	1	1
K	16" Drawer Slides (pre-installed sets) 	2	2
L	Door Roller (pre-installed sets) 	4	4
M	#6 x 5/8" Undercut Screw AB (inserted) 	32	32
N	#6 x 3/4" Philtruss Screw (inserted) 	12	12
O	#6 x 1/2" Undercut Screw AB (inserted) 	4	4
P	#6 x 3/4" Flat Head Screw (inserted) 	20	20
Q	#6 x 1/2" Philtruss Screw (inserted) 	12	12
R	#6 x 5/8" Philtruss Screw (inserted) 	24	26
S	#8 x 1-3/8" Lo-Profile Screw (inserted) 	18	18
T	#8 x 1" Pan Head Screw (inserted) 	8	8
U	#8 x 1-1/4" Pan Head Screw (inserted) 	20	22
V	#8 x 7/8" Black Lo-Profile Screw (inserted) 	36	44
W	#8 x 1-3/4" Pan Head Screw (inserted) 	14	16

**2093DUETb Addison 54"W Sound Bar Media Console
2094DUETb Addison 64"W Sound Bar Media Console**

Parts List

Part	Description	Quantity	
		2093DUETb	2094DUETb
X	#8 x 1-5/8" Black Screw (inserted) 	9	9
Y	#8 x 1-5/8" Machine Screw Tuscan (installed) 	4	4
ZA	Drawer Stop (attached) 	4	4
ZB	1/4" x 20mm Insert Nut (inserted) 	4	4
ZC	5/32" x 10mm Insert Nut (inserted) 	4	4
ZD	Black Walnut Pull (attached) 	2	2
ZE	Turn Button (attached) 	4	4
ZF	Front 4-Hole Bracket (attached) 	2	2
ZG	Back 6-Hole Bracket (attached) 	2	2
ZI	Shelf Bracket (installed) 	4	4
ZJ	Slotted Leveler (installed) 	4	4
ZK	Leveler Adjustment Key (attached to Owners Manual) 	1	1
TS	Media Tipping Restraint (attached)	1 set	1 set

2094 shown in the illustrations.

2093DUETb Addison 54"W Sound Bar Media Console
2094DUETb Addison 64"W Sound Bar Media Console
Assembly Instructions

Tools Required: Phillips Screwdriver, Pencil.

Tool Provided: Leveler Adjustment Key in the Zip bag taped to the Owner's Manual and Safety Guide.

1. Remove screws from the plywood supports and side aprons. Recycle or discard. See Figure 1.

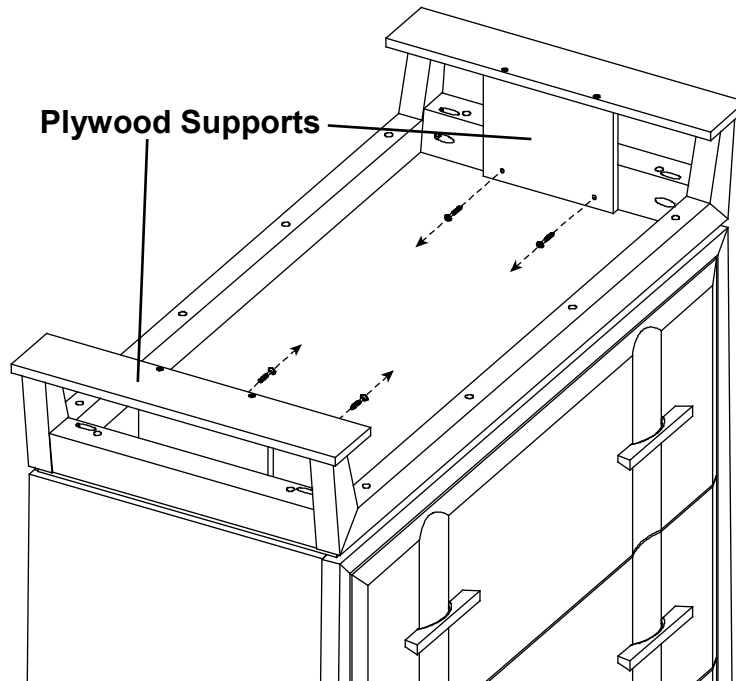

Fig. 1

2. Place the unit at its final destination. Use the Leveler Adjustment Key (ZK), found in the Zip bag taped to the Owner's Manual and Safety Guide to rotate the Slotted Levelers (ZJ) on the bottoms of the legs until the unit is level. See Figures 2 and 2a.



Fig. 2

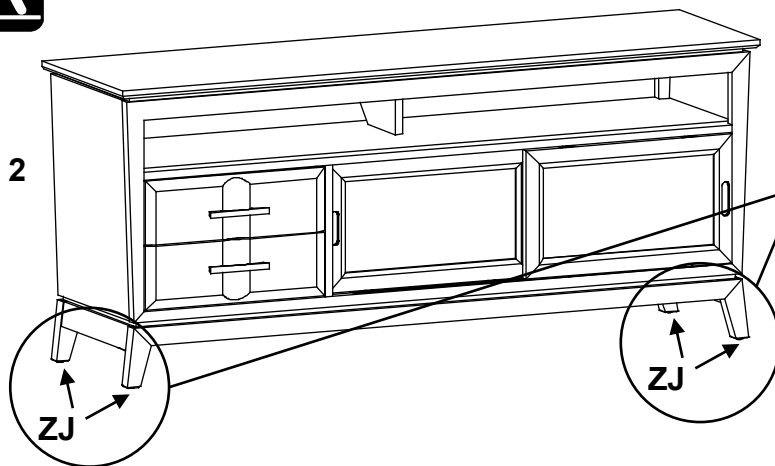
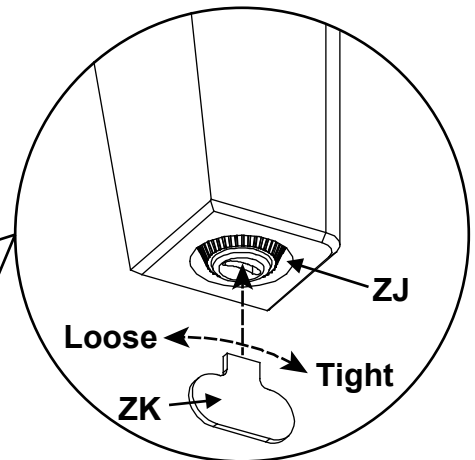

Fig. 2a



2093DUETb Addison 54"W Sound Bar Media Console
2094DUETb Addison 64"W Sound Bar Media Console
Assembly Instructions

3. To insert your media components and access wires more easily, you may want to remove the Removable Backs (D). To do so, unlock the Turn Buttons (ZE) as shown in Figures 3 and 3b. Slide the Backs away and place them off to the side. After installing the components, slide the Backs (D) behind the Drawer Stops (ZA) and lock the Turn Buttons. See Figures 3, 3a, 3b, 3c.

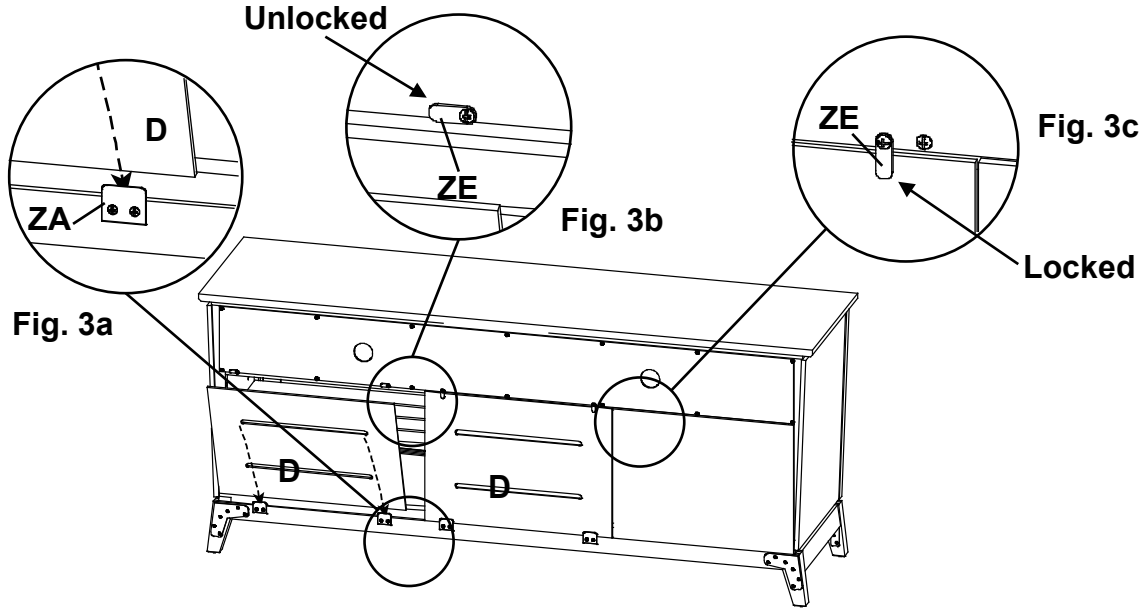

Fig. 3

4. To remove the doors (F & G) shift both doors to the center of the case. Shift the Outside Door (G) to one side, reach behind the top rail of the door and locate the pin portion of the Door Roller (L). See Figure 4. Slide the lock lever downward as shown in Figure 4a. Then shift the door to the other side and slide the lever down on that piece. You may then tip the upper edge of the door forward and remove the door. Remove the Inside Door (F) in the same manner. To insert the doors reverse this process. Be sure to slide the lock lever up to lock the Door Rollers (L). See Figures 4, 4a, 4b.

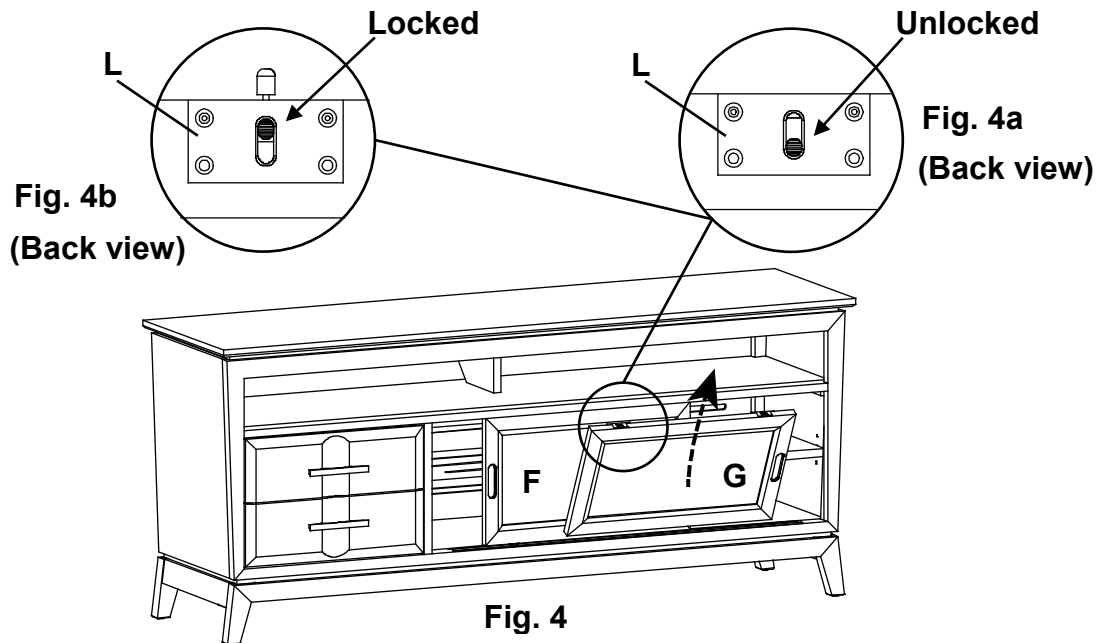

Fig. 4

2093DUETb Addison 54"W Sound Bar Media Console
2094DUETb Addison 64"W Sound Bar Media Console
Assembly Instructions

5. To move the Adjustable Shelf (C), remove the #6 x 1/2" Undercut Screws (O) and the Shelf (C). Reposition the Shelf Brackets (ZI) to the desired positions, replace the shelf and insert the screws. See Figures 5 and 5a.

Doors removed for illustration purposes.

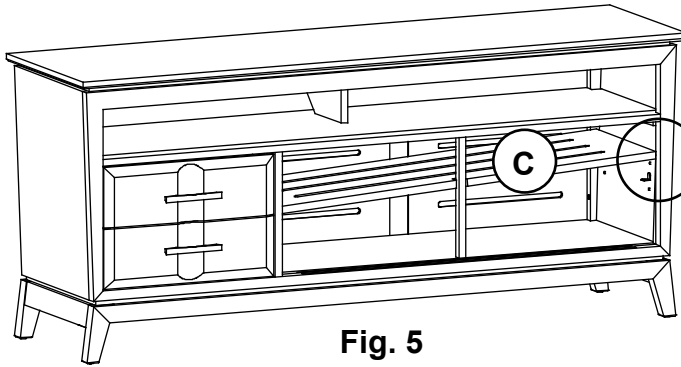

Fig. 5

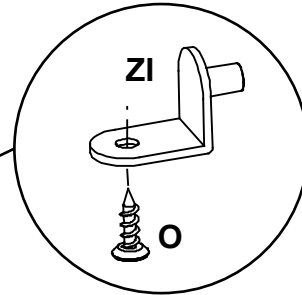

Fig. 5a

Continued on Page 7





Media Furniture Tipping Restraint Instructions



Safety First! Anchor It!

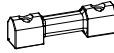

Before you begin this assembly, identify each part and make sure the quantities received match what is on this list. If you need to replace a part, contact Whittier Wood Furniture customer service and refer to the following list for its name and letter code.

Part	Description		Quantity
A	Cam Buckle and Short Strap (installed)		1
B	Plastic Bracket (installed)		1
C	1" x 1000mm Long Strap (installed)		1
D	#8 x 3" Pan Head Screw		2
E	#10 x 1" Oval Head Screw (inserted)		1
F	Washer		1

If you have a stone or tile floor or do not wish to drive screws into the corner of the baseboard and floor see the instruction included inside the tipping restraint kit for an alternate installation.

- Decide where you want to place the piece of furniture in your room. Mark the baseboard with a pencil mark directly behind the location where the tipping restraint is attached to your item. Move the item away from the wall far enough to allow you to access the spot where the baseboard meets the floor. Position the straps and Plastic Bracket (B) as shown in Figures 6 and 6a with the angled corners of the Plastic Bracket (B) firmly placed against the seam of the baseboard and floor. Attach by driving #8 x 3" Pan Head Screws (D) through the holes in the Plastic Bracket (B) into the seam below the baseboard where it meets the floor. See Figures 6 and 6a.

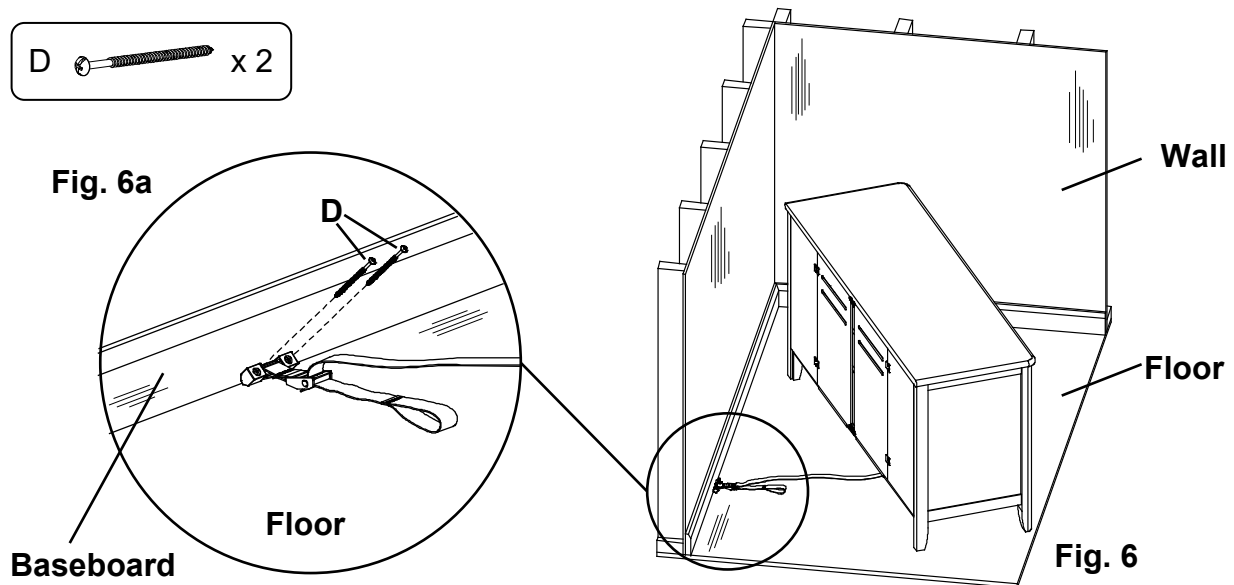

2093DUETb Addison 54"W Sound Bar Media Console
2094DUETb Addison 64"W Sound Bar Media Console
Assembly Instructions

7. Move the item back into position against the wall and reach underneath the piece of furniture to grasp the loop in the free end of the strap. Pull the free end of the strap until portion between the Cam Buckle (A) and the back apron of the item is tight. See Figures 7 and 7a. If you need to move the piece of furniture reach beneath and locate the buckle which connects the two sections of the strap and depress the release lever, then pull on the section of strap that is between the buckle and the back apron of the furniture until there is enough slack to allow you to pull the item away from the wall.

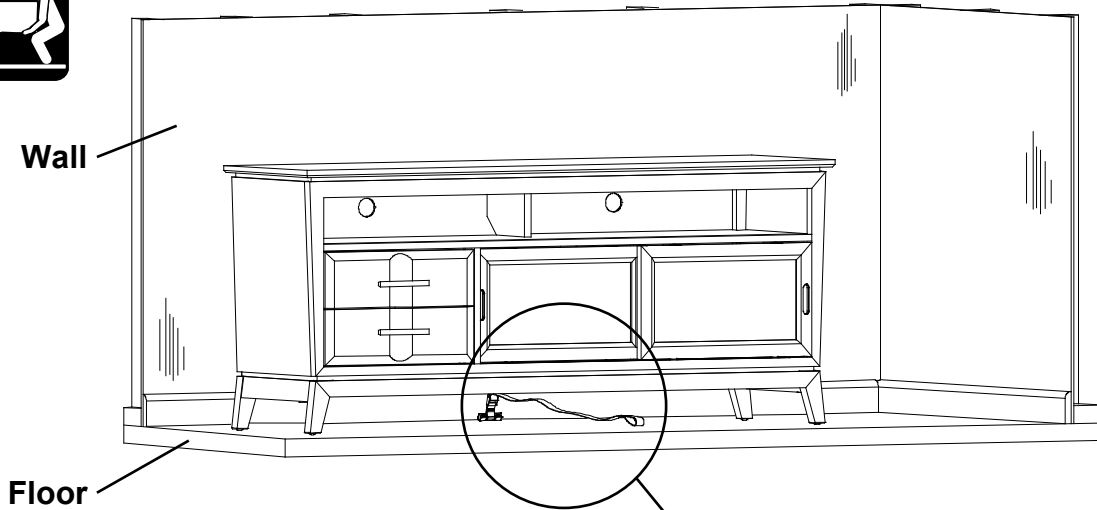

Fig. 7

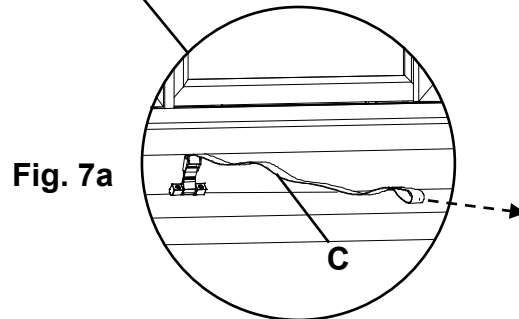

Fig. 7a